

*Eastern*

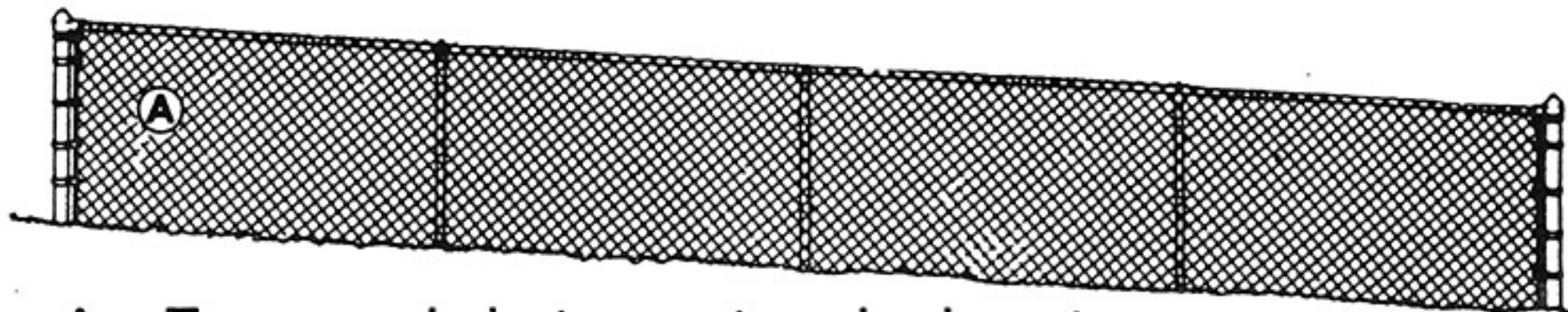


STEP • BY • STEP  
METHOD  
FOR INSTALLING  
YOUR OWN

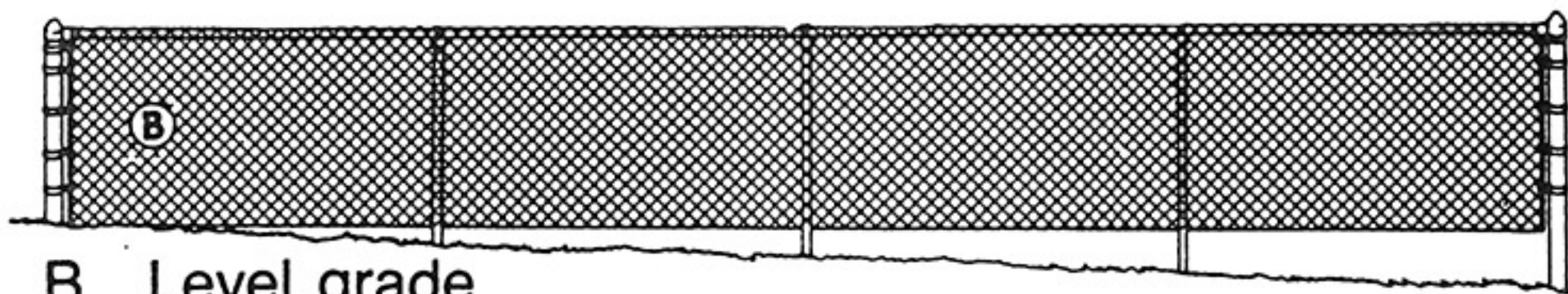
# CHAIN LINK FENCE

HOMES  
YARDS  
SWIMMING POOLS

## HINTS FOR ERECTING CHAIN LINK FENCE



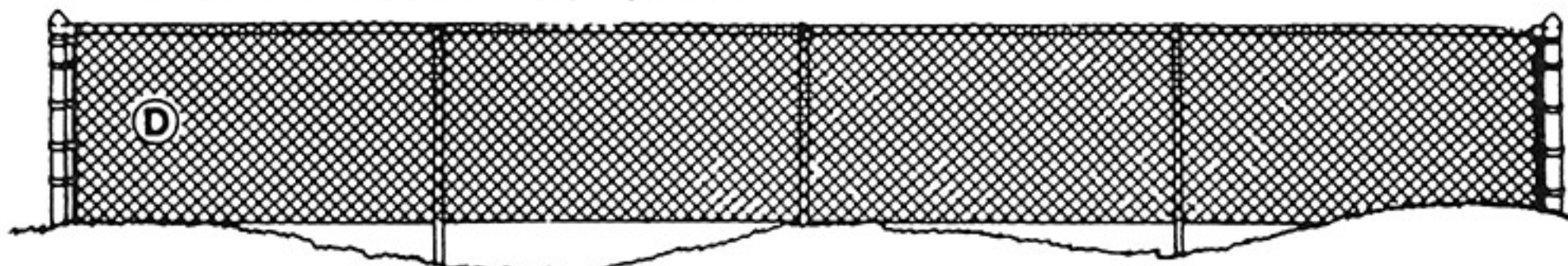
A Even grade between terminal posts



B Level grade



C Fence following grade



D Level grade with rolling terrain

# HOW TO ERECT CHAIN LINK FENCE

## STEP 1 - SURVEY PROPERTY LINES

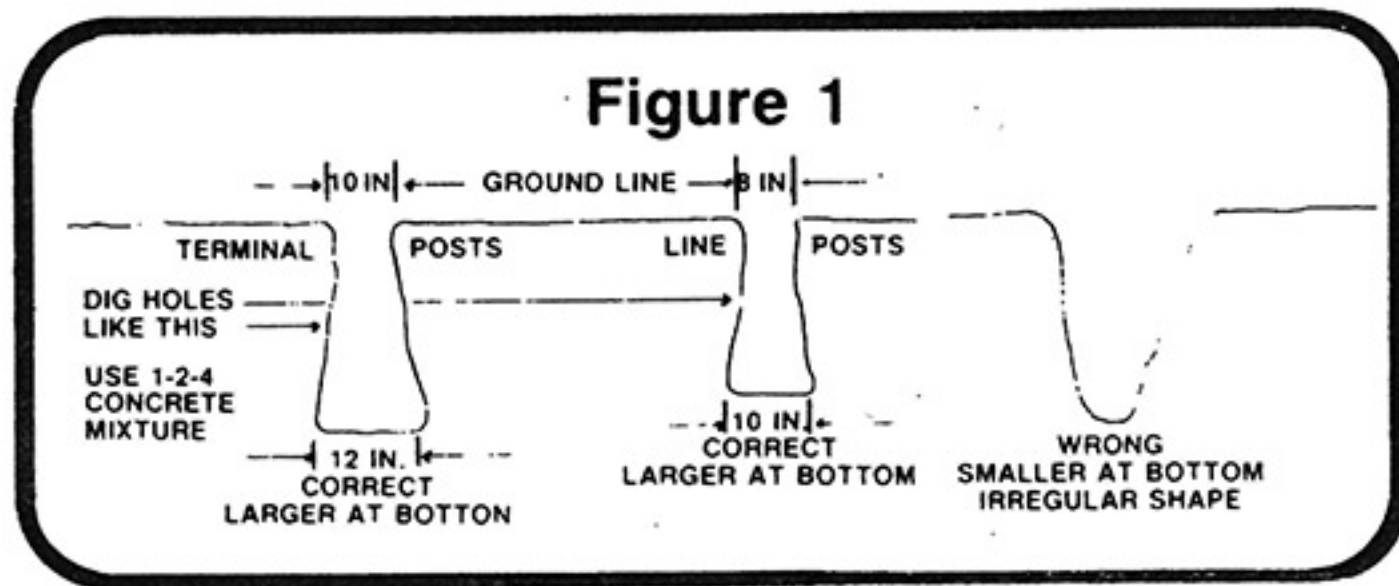
Be sure that the desired location of fence lines do not exceed property lines. *This is very important.* We recommend that all posts be set approximately 4" inside of the property line to avoid encroaching on adjoining property with the concrete foundations. This may be done by stretching string or chalk lines on the property line and setting posts approximately 4" inside of them.

## STEP 2 - LOCATE AND SET TERMINAL POSTS

First determine the location of end, corner, and gate posts (which are referred to as terminal posts).

Distance between gate posts is determined by adding the actual width of the gate to an allowance for hinges and latches. Single walk gates require 3<sup>3</sup>/<sub>4</sub>" for hinges and latches and double drive gates require 5<sup>1</sup>/<sub>2</sub>". For example, a 3 foot walk gate should measure 32<sup>1</sup>/<sub>4</sub>" wide. Adding 3<sup>3</sup>/<sub>4</sub>" to the width means that the distance between posts (inside face to inside face) should be 36". (See Figure 13.)

Now, dig the holes as shown below in Figure 1. (To determine depth of hole see Figure 2 - Measurement C.)



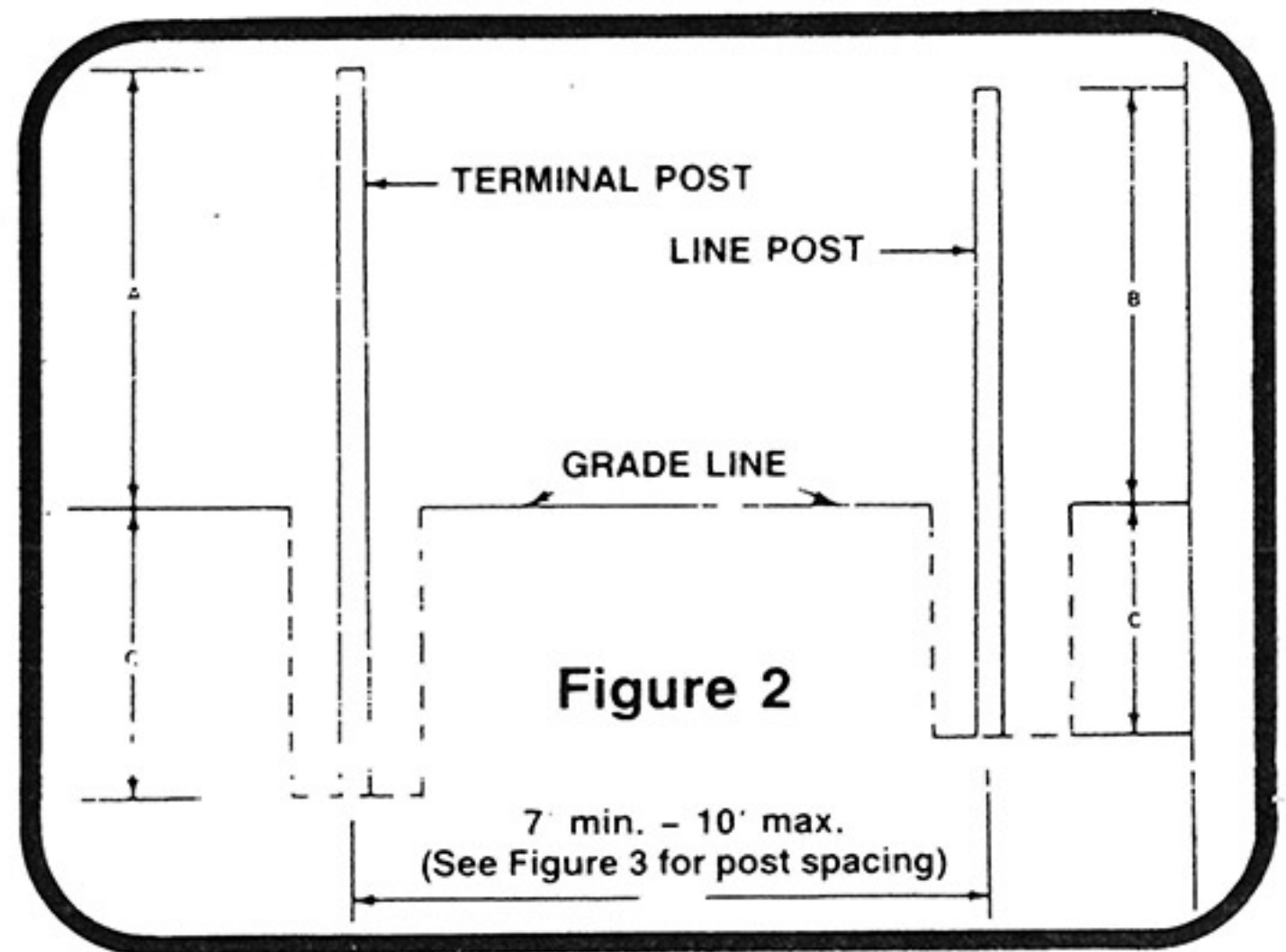
Next, mark all posts with crayon or chalk for the correct height of fence you are installing (see Figure 2 →). Terminal posts should be set 2" higher than the width of the fabric and line posts 2" lower than the fabric width.

Set the terminal posts in concrete using a concrete mix as follows: 1 part cement, 2 parts sand, and 4 parts gravel. Mix a fairly heavy solution as too much water weakens concrete and may cause cracking. Use a carpenter's level to set posts plumb. Crown all post footings for water drainage by sloping concrete away from post.

**WARNING: WHEN DIGGING POST HOLES WATCH FOR AND CHECK OUT ANY UNDERGROUND CABLE OR PIPE LINES AND CONTACT YOUR LOCAL UTILITY.**

## STEP 3 - LOCATE AND SET LINE POSTS

Mark the grade line on all line posts measuring from the top down as shown in Figure 2. Then measure the distance between terminal posts and check line post spacing chart (Figure 3 below) for exact distance to allow between line posts.

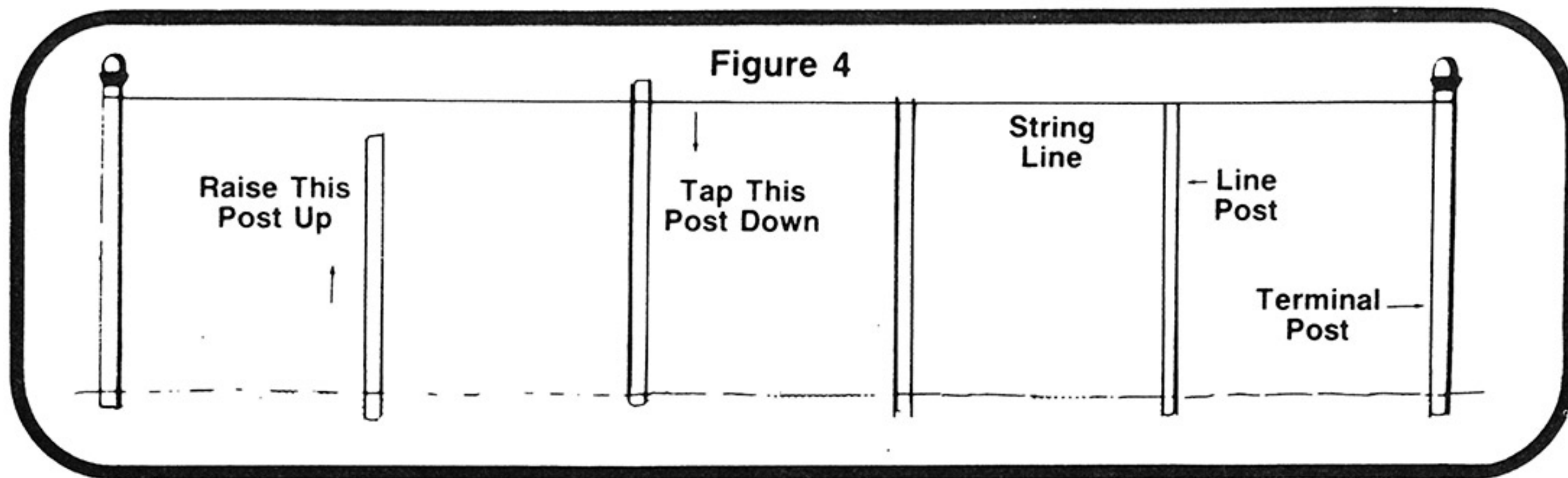


\*MEASUREMENT C - Depth that post will be in the ground will be determined by lengths of posts being used, after A or B dimension is subtracted from overall length of posts.

Fence Height	A	B	C
3' 6"	44"	40"	*
4' 0"	50"	46"	*

Space	Set Post Apart	Space	Set Post Apart	Space	Set Post Apart	Space	Set Post Apart	Space	Set Post Apart
30 ft.	10 ft.	51 ft.	8 ft. 6 in.	71 ft.	8 ft. 9 in.	92 ft.	9 ft. 2 in.	112 ft.	9 ft. 4 in.
31 ft.	7 ft. 9 in.	52 ft.	8 ft. 8 in.	72 ft.	9 ft.	93 ft.	9 ft. 3 in.	113 ft.	9 ft. 5 in.
32 ft.	8 ft.	53 ft.	8 ft. 10 in.	73 ft.	9 ft. 2 in.	94 ft.	9 ft. 5 in.	114 ft.	9 ft. 6 in.
33 ft.	8 ft. 3 in.	54 ft.	9 ft.	74 ft.	9 ft. 3 in.	95 ft.	9 ft. 6 in.	115 ft.	9 ft. 7 in.
34 ft.	8 ft. 6 in.	55 ft.	8 ft. 2 in.	75 ft.	9 ft. 4 in.	96 ft.	9 ft. 7 in.	116 ft.	9 ft. 8 in.
35 ft.	8 ft. 9 in.	56 ft.	9 ft. 4 in.	76 ft.	9 ft. 6 in.	97 ft.	9 ft. 7 in.	117 ft.	9 ft. 9 in.
36 ft.	9 ft.	57 ft.	9 ft. 6 in.	77 ft.	9 ft. 7 in.	98 ft.	9 ft. 8 in.	118 ft.	9 ft. 10 in.
37 ft.	9 ft. 3 in.	58 ft.	9 ft. 8 in.	78 ft.	9 ft. 9 in.	99 ft.	9 ft. 9 in.	119 ft.	9 ft. 10 in.
38 ft.	9 ft. 6 in.	59 ft.	9 ft. 10 in.	79 ft.	9 ft. 10 in.	100 ft.	10 ft.	120 ft.	10 ft.
40 ft.	10 ft.	60 ft.	10 ft.	80 ft.	10 ft.	101 ft.	9 ft. 2 in.	121 ft.	9 ft. 3 in.
41 ft.	8 ft. 2 in.	61 ft.	8 ft. 8 in.	81 ft.	9 ft.	102 ft.	9 ft. 3 in.	122 ft.	9 ft. 4 in.
42 ft.	8 ft. 5 in.	62 ft.	8 ft. 10 in.	82 ft.	9 ft. 1 in.	103 ft.	9 ft. 4 in.	123 ft.	9 ft. 5 in.
43 ft.	8 ft. 6 in.	63 ft.	9 ft.	83 ft.	9 ft. 3 in.	104 ft.	9 ft. 5 in.	124 ft.	9 ft. 6 in.
44 ft.	8 ft. 9 in.	64 ft.	9 ft.	84 ft.	9 ft. 4 in.	105 ft.	9 ft. 6 in.	125 ft.	9 ft. 7 in.
45 ft.	9 ft.	65 ft.	9 ft. 3 in.	85 ft.	9 ft. 6 in.	106 ft.	9 ft. 7 in.	126 ft.	9 ft. 8 in.
46 ft.	9 ft. 2 in.	66 ft.	9 ft. 5 in.	86 ft.	9 ft. 7 in.	107 ft.	9 ft. 8 in.	127 ft.	9 ft. 9 in.
47 ft.	9 ft. 5 in.	67 ft.	9 ft. 7 in.	87 ft.	9 ft. 8 in.	108 ft.	9 ft. 9 in.	128 ft.	9 ft. 10 in.
48 ft.	9 ft. 7 in.	68 ft.	9 ft. 8 in.	88 ft.	9 ft. 9 in.	109 ft.	9 ft. 10 in.	129 ft.	9 ft. 10 in.
49 ft.	9 ft. 9 in.	69 ft.	9 ft. 10 in.	89 ft.	9 ft. 10 in.	110 ft.	10 ft.		
50 ft.	10 ft.	70 ft.	10 ft.	91 ft.	9 ft. 2 in.	111 ft.	9 ft. 3 in.		

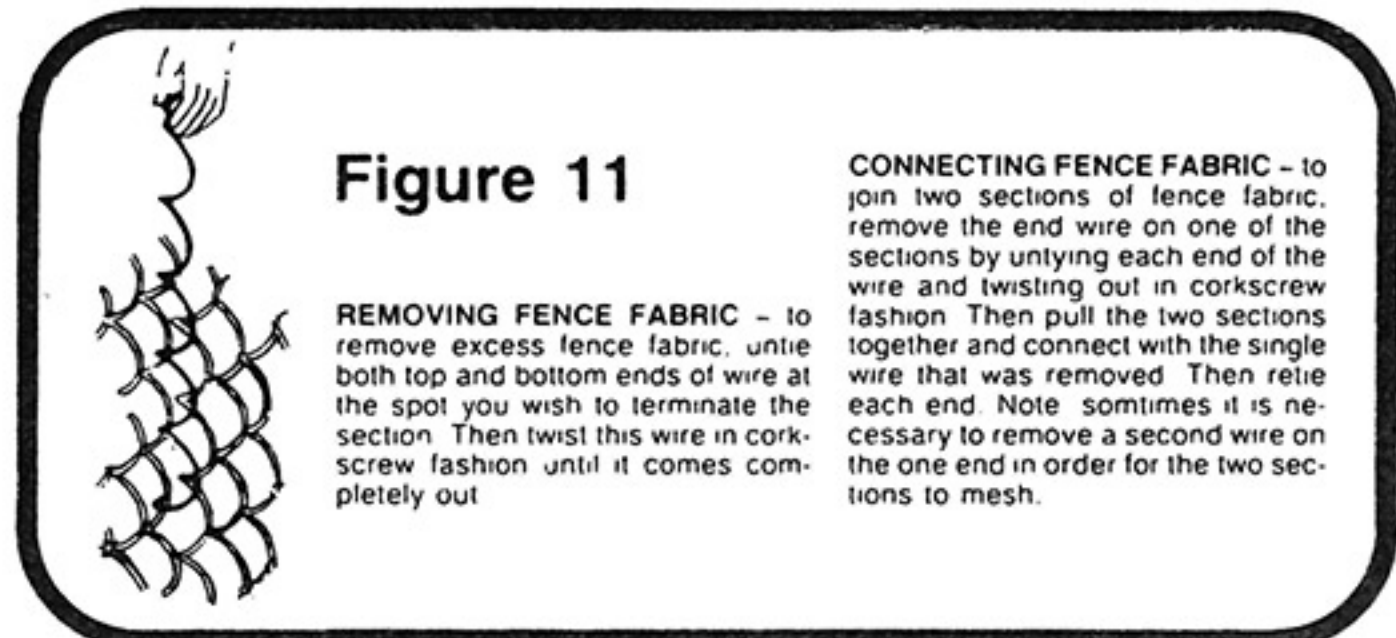
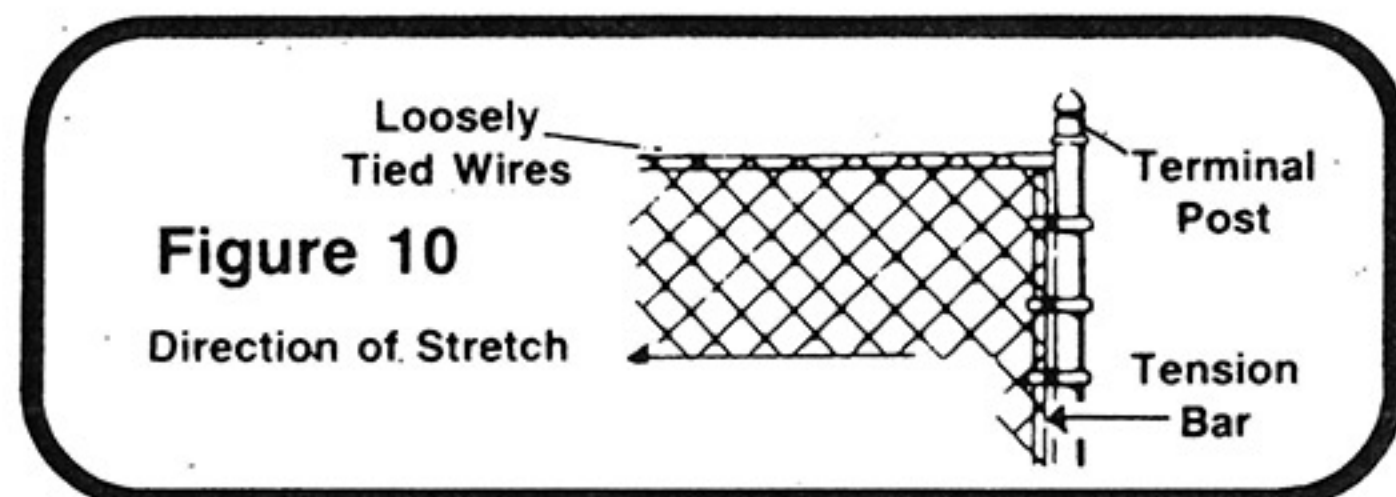
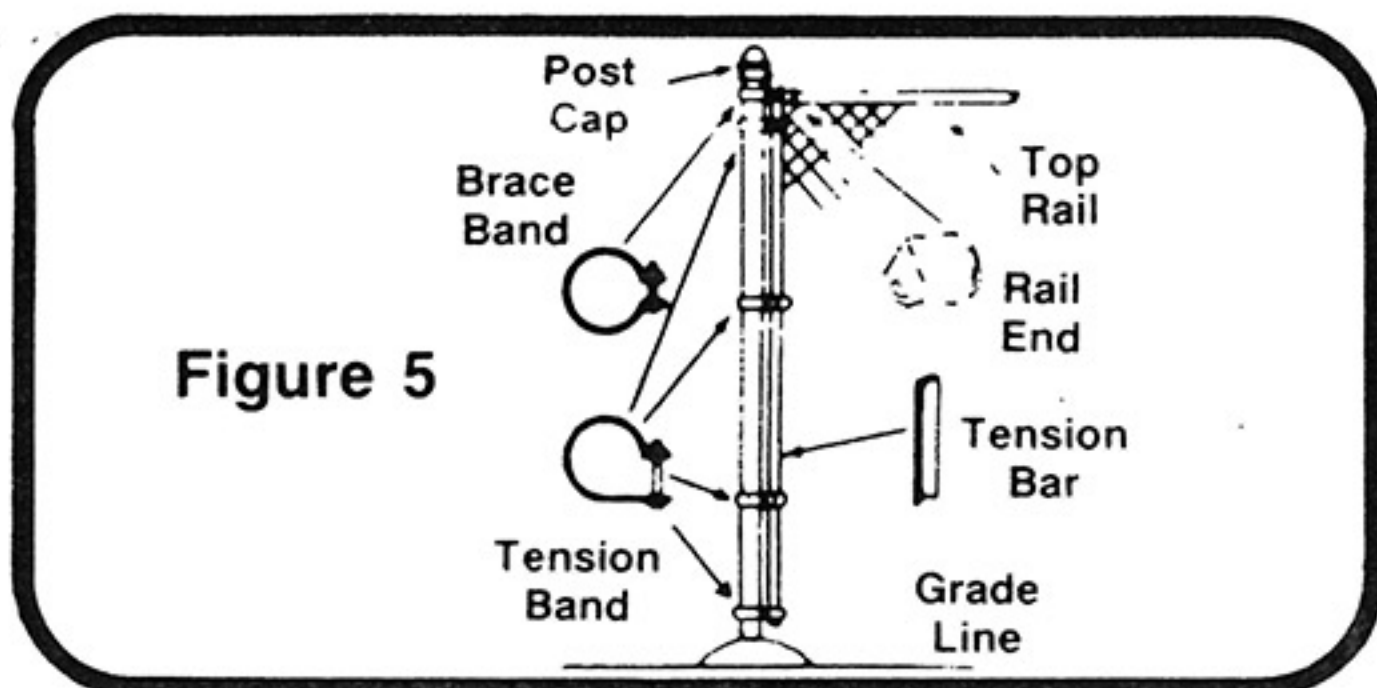
Next, stretch a masons line from outside of terminal posts to outside of terminal posts (be sure the concrete has set up sufficiently so as not to lose plumb). The line post holes should be lined up so that when they are set in the center of their holes, their centers will line up with the terminal post centers. This means the outside faces of the line posts will be about 1/4" inside of the line stretched between the outside of the terminal posts. Now dig the line post holes and set the line posts.



Next, stretch your masons line taut four inches below terminal post tops and use as a guide to align height of line posts (see Figure 4 above) If necessary to adjust height of any post either up or down, simply raise or lower post as illustrated before concrete sets up. Use your level to keep plumb while adjusting post height.

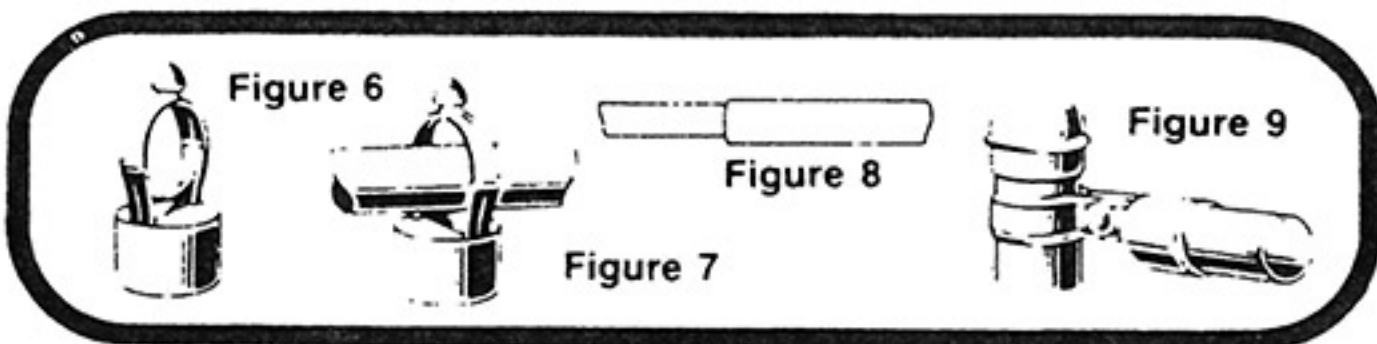
### STEP 4 - APPLY FITTINGS TO TERMINAL POSTS

Check material list and fittings identification chart. After the posts have been installed and the concrete allowed to set, slip tension and brace bands on terminal posts. (See Figure 5.) The tension bands should be spaced approximately 10-12" apart. Do not spread or distort bands. All bolt heads for bands are on the outside of fence and the threaded ends are on the inside. Then apply all terminal post caps.



### STEP 5 - APPLY TOP RAIL

Next, attach loop caps. (See Figure 6.) They are set with the top rail hole offset toward the outside of the fence making flush the outside face of the top rail through the loop caps. (See Figure 7.) Join the top rail with swaged end where required. (See Figure 8.) End of the top rail fits into rail end fittings on the terminal post. (See Figure 9.)



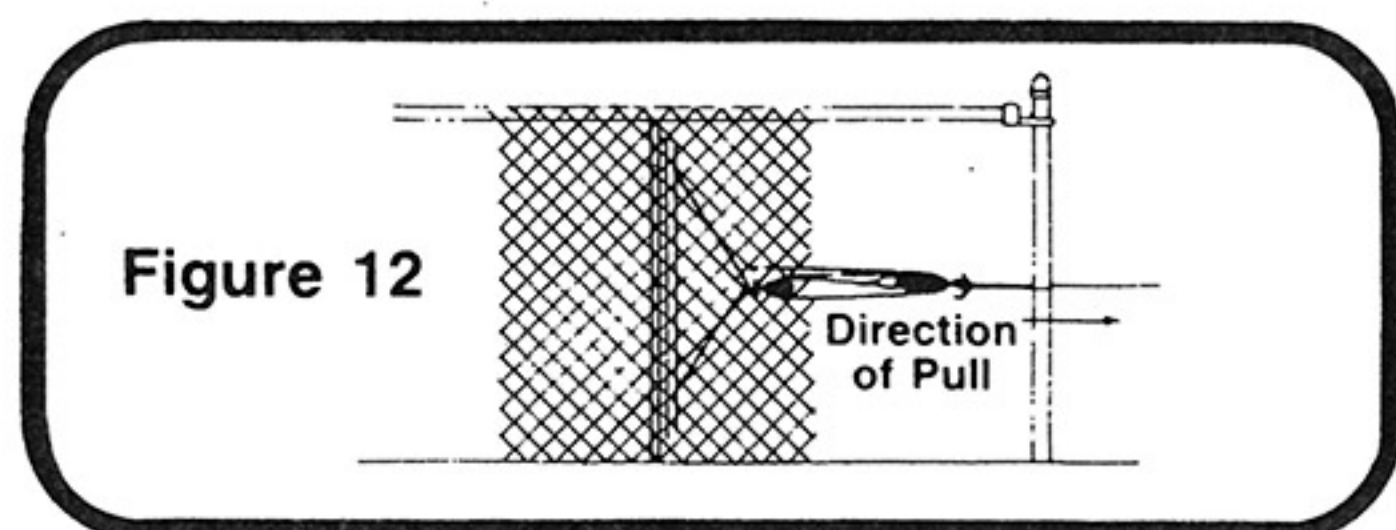
### STEP 6 - HANG FABRIC

After assembling the framework, unroll the fabric on the ground along the fence line starting at a terminal post. Then slide tension bar thru the last link in your fabric and attach this combination to the terminal post using tension band and bolts provided. (See Figure 10.) If more or less fabric is needed to span the opening, an additional amount can be connected or removed as shown in Figure 11. The fabric should be on the outside face of all posts and loosely attached to the top rail by a tie wire.

### STEP 7 - STRETCH FABRIC

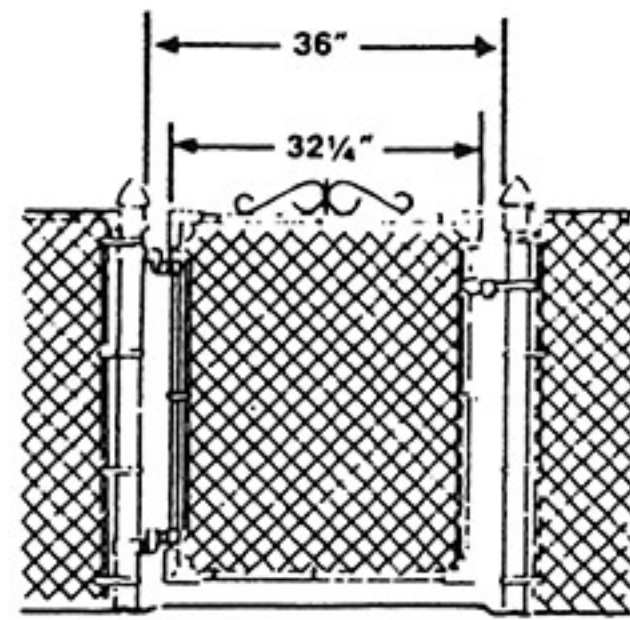
Fabric should be stretched from the terminal post already attached to the opposite terminal post. Insert tension bar in end of fabric and attach fence stretcher to bar (ratchet type power pull, large carpenter's clamps, block and tackle, or similar device may be used. Most wire stretching tools of this type can be rented or borrowed locally.)

As you stretch the fabric test it for tension (it is stretched enough when it gives slightly). The top of the fabric should be located approximately 1/2" above the top rail to insure proper height. After fence fabric is sufficiently tight, remove the excess fabric as shown in Figure 11, and connect the tension bar to the post with tension bands. Also fasten the fabric to the top rail and line posts with tie wires spaced approximately 18" apart.

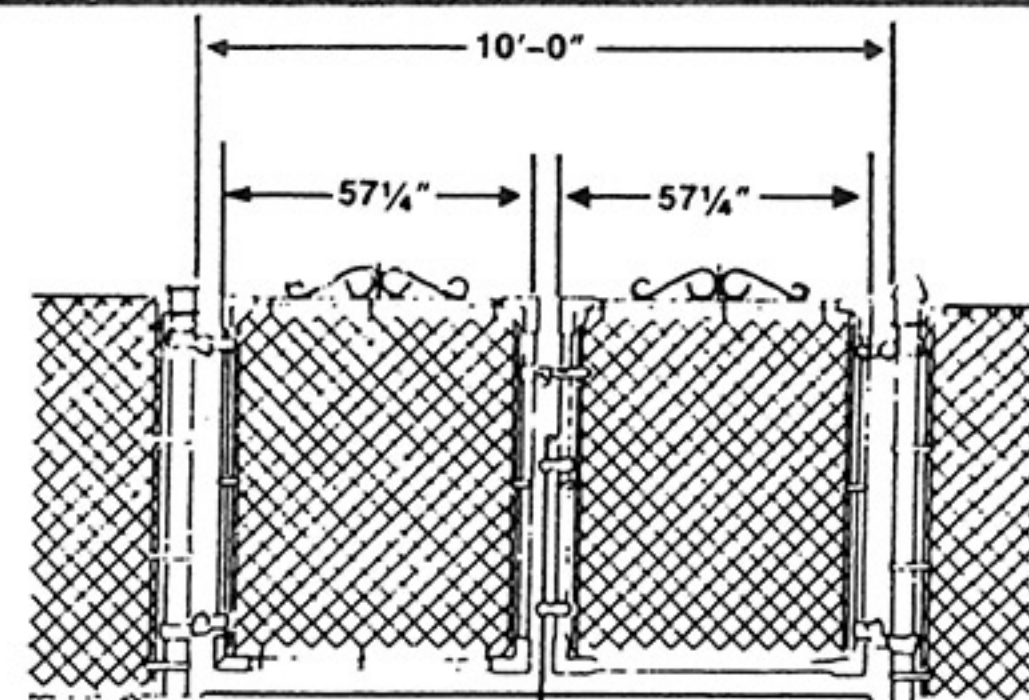


**Figure 13**

**3' WALK GATE**



**10' DOUBLE DRIVE GATE**



**STEP 8 – HANG GATES**

After the entire fence has been completed, apply male hinges to one of the gate posts, hanging the top hinge upside down thus preventing the gate from being lifted off. Loosely apply female hinges on the gate frame and slip them onto the male hinges that have been installed on the gate post. Set hinges to allow for full swing of the gate and align the top of the gate with the top of the fence. Tighten all hinges securely. Install gate latch for single gates. For double gates, use the same procedure as on walk gates but install center latching device (fork latch).

**MATERIALS NEEDED FOR RESIDENTIAL CHAIN LINK FENCE**

PIECES	ITEM—DESCRIPTION	QUANTITY TO USE
(1)	Fabric (50 feet per roll)	Divide total footage by 50 and round up
(2)	Top Rail Swaged End 1 3/8" or 1 5/8" O.D.	Total footage
(3)	Line Post 1 5/8" or 2" O.D.	Divide total footage by 10 and round up
(4)	Loop Caps match to post and rail	Use 1 per line post
(5)	Terminal Post 2" or 2 1/2" O.D.	—
(6)	Tension Bar	Use 1 per end or gate post, 2 per corner post
(7)	Brace Band	Use 1 per tension bar
(8)	Rail Ends	Use 1 per tension bar
(9)	Tension Band	Use 4 per tension bar or 1' per foot of fence height
(10)	5/16" x 1 1/4" Carriage Bolts	Use 1 per tension or brace band
(11)	Terminal Post Caps	Use 1 per terminal post
(12)	Alum Hook Ties	Use 1 per foot of fence—Packaged 100 per bag
(13)	Walk Gate (3' or 3 1/2' wide)	—
(14)	Double Drive Gate (10' or 12' wide)	—
(15)	Male Hinge	Use 2 per walk gate and 4 per double drive gate
(16)	3/8" x 3" Carriage Bolts	Used with the male hinge, 1 per hinge
(17)	Female Hinge 1 3/8"	Use 2 per walk gate and 4 per double drive gate
(18)	3/8" x 1 3/4" Carriage Bolts	Used with female hinge, 1 per hinge
(19)	Fork Latch	Needed on walk gates only—1 per gate

**TOOLS YOU WILL FIND USEFUL IN INSTALLING YOUR FENCE**

- |  |  |
|--|--|
| 1. Post Hole Digger  | 6. Pliers  |
| 2. Wheelbarrow, Shovel and Hoe to mix and transport concrete | 7. Fence Stretcher (Block and tackle, ratchet type power pull, etc.) |
| 3. Tape Measure  | 8. 1/2" X 9/16" Wrench or Crescent Wrench                            |
| 4. Level   | 9. Hacksaw or Pipe Cutter  |
| 5. String and Stakes or Mason's Line                         |  |